

PANDUIT

PANTHER™ LS8EQ

Quick Reference Card



Printer Tech Support – 866-871-4571
Rev. 1 – 6/01/14

LS8EQ Printer and Accessories

Part No.	Description
LS8EQ-KIT-ACS	Includes LS8E printer, 1 cassette of S100X150VAC, 6 AA batteries, rigid carrying case, LS8-PCKIT, LS8-IB, LS8-WS, and LS8E-ACS.
LS8EQ-KIT	Includes LS8E printer, 1 cassette of S100X150VAC, 6 AA batteries, rigid carrying case, LS8-PCKIT, LS8-IB, and LS8-WS.
LS8EQ	Includes LS8E printer, 1 cassette of S100X150VAC, and 6 AA batteries
LS8E-ACS*	120 VAC power adapter for North America
LS8E-ACA*	120 - 240 VAC power adapter for Australia
LS8E-ACC*	120 - 240 VAC power adapter for China
LS8E-ACE*	120 - 240 VAC power adapter for Europe
LS8E-ACU*	120 - 240 VAC power adapter for the United Kingdom
LS8-PCKIT	Includes USB cable and CD with PANTHERLINK™ software and LS8 operator's manual.
LS8-IB	Protective impact bumper
LS8-WS	Wrist strap
LS8-CLN	Cleaning kit

*Cannot be used to charge batteries

PT™ Label Cassettes

- Print self-laminating labels, heat shrink tubing, die-cut component labels, and continuous tapes
- Automatic cassette recognition adjusts printer settings
- Integrated memory device saves last legend used for later recall and records number of labels remaining

PT™ Label Cassettes

Label Material	Example Part No.	Typical Application
Self-Laminating Vinyl*	S100X150VAC	Wire/Cable marking
Heat Shrink Polyolefin^	H100X044H1C	Wire/Cable marking
Vinyl Cloth	N100X125CBC	Wire/Cable marking
Nylon Cloth Tape^	T100X000C1C-BK	Wire/Cable marking
Flag Labels	F100X150AJC	Wire/Cable marking
Marker Plates^	M300X050Y6C	Wire/Cable marking
Adhesive Polyester	C200X100YJC	General component labeling
Non-Adhesive Polyester	C390X030Y1C	Network systems component labeling
Polyolefin Tape	T031X000FJC-BK	Terminal block labeling
Colored Vinyl Tape*	T100X000VXC-BK	Safety/Facility identification

* Available in a variety of colors.

^ Available in white and yellow.

Getting Started

- Remove battery door on back of printer.
- Install 6 AA batteries according to the molded indicators in the battery compartment.

Do not install batteries incorrectly. Doing so may cause damage to the printer electronics. When replacing batteries, replace all 6 of them at the same time.

- Reinstall the battery door.
- Remove cassette door on back of printer.
- Install the label cassette. Press firmly to lock cassette in place. The printer will power on automatically.
- Reinstall cassette door.
- Move print head latch to locked position.

You are now ready to begin printing!

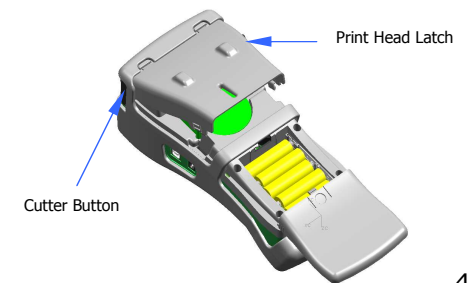

LS8EQ Display Screen

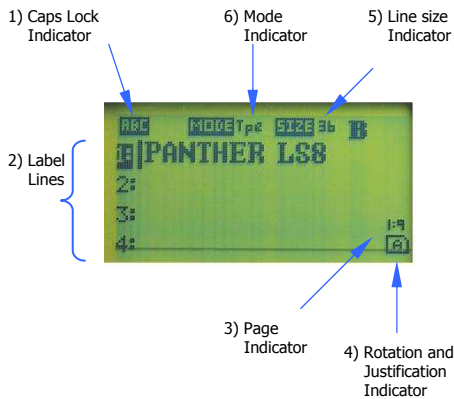

LS8EQ Tools Menu

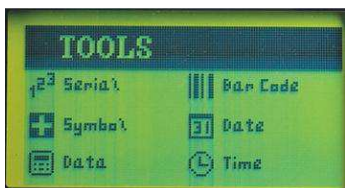

- Serialization
- Symbol
- Data List
- Bar Code
- Date
- Time

LS8EQ Keypad Functions

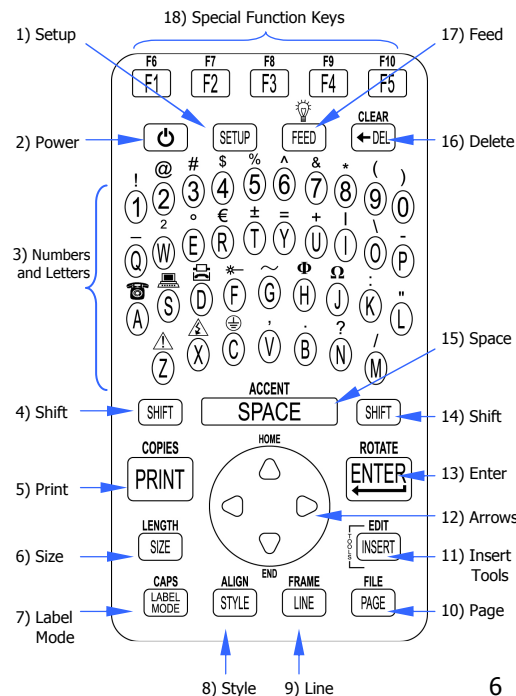

Text Font Size

Point Size	Print Sample
4	ABC
6	ABC
8	ABC
10	ABC
12	ABC
16	ABC
24	ABC
36	ABC
48	AB

Text Font Style

NORMAL

NORMAL + UNDERLINED

BOLD

BOLD + UNDERLINED

Change text style for all characters at once or just for characters to be inserted next.

Serialization Tool

1. Type "1A-A"
2. Press the INSERT key and select  Serial
3. Enter a start value of 01, stop value of 02, and increment value of 1
4. Press ENTER
5. Press PRINT

Example using S100X150VAC, self-laminating wire/cable markers:

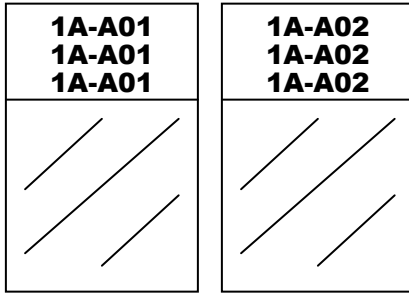

9

Symbol Tool

1. Press the INSERT key and select  Symbol
2. Select symbol number 22 from the library
3. Press ENTER
4. Press SPACE
5. Type "CAUTION"
6. Press PRINT

Example using T100X000VXC-BK, black on yellow continuous vinyl tape:

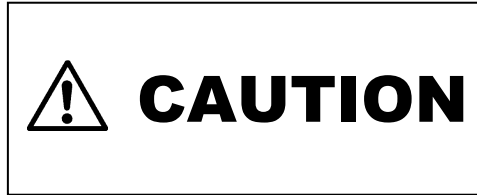

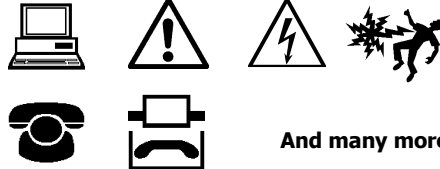

82 Symbols, Including:



10

Data List Tool

1. To create a new data list, press the INSERT key and select  Data
2. Scroll down to "Create/Edit"
3. Press ENTER
4. Begin typing data. Use PAGE key to move forward to next page or backward to previous page.
5. Press F5 key to exit the data list
6. Select [S]ave
7. Scroll down to "Save and Exit"
8. Press ENTER
9. Press PRINT

1. To recall an existing list, press the INSERT key and select  Data
2. Scroll right to the saved list's location (1-4)
3. Scroll down to "Save and Exit"
4. Press ENTER
5. Press PRINT

- The Data List Tool allows files to be created on a computer and then imported into the LS8E printer.
- Create a Data List in Microsoft Excel[^] and then use *PANTHERLINK*[™] software to import it. Detailed instructions are included in the LS8EQ operator's manual and online at www.panduit.com

11

Bar Code Tool

1. Press the INSERT key and select  Bar Code
2. Scroll right and type text in the window
3. Press ENTER
4. Press ENTER
5. Press PRINT

Example using T100X000VPC-BK, black on white continuous vinyl tape:

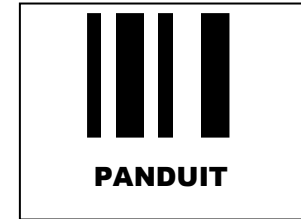

- Bar code formats available include Code 39 and Code 128.

12

Time Tool

1. Press the INSERT key and select  Time
2. If the time has not been set since powering on, then set the time.
3. Press ENTER

Example using C100X050YJC, polyester component label:



Date Tool

1. Press the INSERT key and select  Date
2. If the date has not been set since powering on, then set the date.
3. Press ENTER

Example using H000X044F1C, heat shrink tubing:

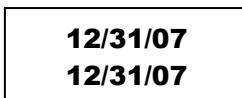

13

Other Functions

- POWER – Turn printer on or off
- SETUP – Access the Set Up menu
- DELETE – Erase characters and tools
- CLEAR – Clear the entire screen
- FEED – Feed labels
-  – Turn the backlight on or off
- PRINT – Print labels
- COPIES – Print multiple copies or selection of pages
- SIZE – Select the text font size
- LENGTH – Set the length of continuous label media
- STYLE – Select the text font style
- ALIGN – Change the label justification
- LINE – Add vertical and horizontal lines to a label
- FRAME – Add a frame around a label
- PAGE – Move to another page
- FILE – Access the file manager
- INSERT – Insert a new tool
- EDIT – Edit an existing tool
- LABEL MODE – Change the label mode
- CAPS – Turn caps lock on or off
- HOME – Move to home position on screen
- END – Move to end position on screen
- SHIFT – Access secondary functions on keypad
- SPACE – Add a space to a label
- ACCENT – Insert an international character
- ENTER – Move to the next line or accept menu changes
- ROTATE – Rotate the label 90, 180, or 270 degrees

14

Set Up Menu

- Languages – Set the printer language
- Units – Select inches or mm
- Bar Code – Set the default bar code settings
- Contrast – Lighten or darken the display
- Heat – Adjust the heat of the print head
- Version – Display the current operating system version number
- Date/Time – Set the time and date. Select the time format and date format
- Factory Defaults – Return printer settings to factory default values
- PC Interface - Print directly from Easy-Mark labeling software, transfer data lists and label files to or from a computer, Interface with Microsoft Excel[^], upgrade the printer operating system
- Cut/Pause – Pause a multi-label print job to cut between labels
- Auto-off – Turn the 5 minute automatic shut-off function on or off

Special Functions (F Keys)

- F1 – Display F key menu
- F2 – Store and recall user profiles
- F3 – Display label cassette information
- F4 – Market and Application Based Label Wizard
- F5 – DIN Mode for DIN Terminal Blocks
- F6 – Quick key for wire marking (use with continuous nylon cloth or vinyl cloth tape)
- F7 – Print Preview

15

Free Downloads Available Online at www.panduit.com:

- Detailed Operator's Manuals in English, French, German, Italian, Spanish, and Portuguese
- Replacement Quick Reference Cards in English, French, German, Italian, Spanish, and Portuguese
- Product bulletin with part ordering information
- Printer upgrading instructions
- Printer firmware upgrade file
- *PANTHERLINK*[™] software download
- Instructions for using the LS8EQ with Easy-Mark Labeling Software
- Instructions for using the LS8EQ with Microsoft Excel[^]
- Interactive flash demonstration

[^]Excel is a registered trademark of Microsoft Corp. in the United States and/or other countries.

PART NO. LS8EQ-QS-A, Rev. 1
Toll free technical support: 1-866-871-4571
Toll free customer service: 1-800-777-3300
Also visit www.panduit.com

16